



ELFA
PRODUCT
BROCHURE

elfa[®]
CREATING SPACE

CREATING SPACE IN EVERYDAY LIFE

We know that clothes, shoes and things fill our homes. We have more things than we actually use and not enough storage for them. With smart storage solutions you will create an overview and everything will have its specific place. Smart storage solutions can give you valuable living space back, that you have lost to temporary solutions.

TRULY MADE TO MEASURE

With a made to measure storage solution you can use even your most challenging spaces for good storage. An adjustable solution lets you re-arrange your storage. You can easily add, remove and reposition drawers, shelves and other pieces as your needs change. Elfa can be used in practically every space in your home thanks to its modular design and good looks. Smart details solves every specific storage need, from your clothing storage to your tools in the garage.

INGENIOUS STORAGE

The Elfa assortment is built on Swedish industrial heritage. Our product development creates clever functions with our own design based on storage knowledge since 1948. With exceptionally strong epoxy-bonded steel, Elfa can easily handle everything from a library of books to garden equipment and clothes.

COMPLETE STORAGE SOLUTIONS

Be proud of your things and create open storage solutions. Let us show you what you can do with your space, visit us in store or online at www.elfa.com.

elfa[®]



GETTING ORGANISED

GET SET IN 3 SIMPLE STEPS	4
WEIGHT AND SECURITY	5

PRODUCTS & PRICES

TOP TRACK AND HANG STANDARD	6
FREESTANDING	7
WALLBANDS & BRACKETS	8
SHELVES	9
DÉCOR	10
CLICK IN DRAWERS & ACCESSORIES	11
CLOSET RODS & ORGANISERS	12
GARAGE, LAUNDRY & CLEANING	13
STORING BOARD	14
ON DOOR STORAGE	14
STARTER PACKS	15-17
DRAWER SYSTEM	18-20
RUNNERS	20

GUIDELINES

ORGANISATIONAL TIPS	21
ASSEMBLY & INSTALLATION	22, 23

INSPIRATION	24 - 31
-------------	---------

GET SET IN 3 SIMPLE STEPS

1. CHOOSE TOP TRACK AND HANG STANDARD OR FREESTANDING

We recommend the Top hang solution to all conventional walls. But if you can't or don't want to screw in your wall, there is a freestanding option.



TOP TRACK & HANG STANDARD
Page 6

The only thing you screw into the wall is the Top track.



FREESTANDING Page 7

A freestanding solution suitable for creating an island of storage or for challenging spaces.

2. ADD SHELVES AND DRAWERS

Add shelves and drawers that suit your need.



SHELVES Page 9 & 10



DRAWERS Page 11

3. COMPLETE FOR SPECIFIC NEEDS

Add functional accessories to complete your solution for different usage



CLOTHING

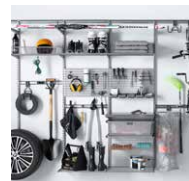

GARAGE & STORAGE



LAUNDRY & CLEANING



OFFICE



ON DOOR STORAGE

WEIGHT AND SECURITY

TYPE OF PRODUCT	SECTION WIDTH		
	45	60	90
Max recommended evenly placed load			
SHELVES (ALL DEPTHS)			
Wire shelf	40 kg	40 kg	30 kg
Wire shelf basket	40 kg	40 kg	40 kg
Melamine shelf	40 kg	40 kg	40 kg
Click-in melamine shelf	40 kg	40 kg	
Décor shelf	40 kg	40 kg	40 kg
Angled shelf metal		22 kg	
Shelf/tray reversible metal Depth 115 mm	16 kg	16 kg	14 kg
Shelf/tray reversible metal Depth 267 mm	22 kg	22 kg	12 kg
Drying shelf		20 kg	20 kg
Click-in work surface		40 kg	
GLIDING FUNCTIONS (ALL DEPTHS)			
Gliding mesh drawer	8 kg	8 kg	
Gliding wire drawer	8 kg	8 kg	
Gliding shoe rack	8 kg	8 kg	
Gliding shoe shelf mesh	8 kg	8 kg	
Gliding pant rack	8 kg	8 kg	
Décor gliding pant rack		8 kg	
Décor gliding drawer frame		8 kg	
Décor gliding drawer frame for front		8 kg	
CLOSET ROD			
Closet rod	22,5 kg	30 kg	45 kg
Expandable valet rod	7 kg	7 kg	7 kg
BRACKET HOOK RACK			
Bracket hook rack	40 kg	40 kg	30 kg
Décor bracket hook rack	40 kg	40 kg	40 kg

TOP HANG SOLUTIONS

A Click-in system top hang solution is based on sections. A section is the area created between two hang standards.

NOTE! Each section is designed to hold 200 kg load.

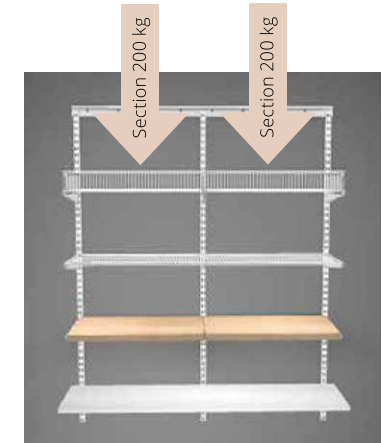

Make sure not to overload each product and to place your load evenly. Find each product maximum load in the list.

TYPE OF PRODUCT	MAX LOAD
Hooks (Garage & Storage)	22,5 kg
Hooks for storing boards	2,3 kg *3 kg
Hooks for storing boards (Garage & Storage)	*2,3 kg 2,5 kg
Accessory hook	3 kg
Basic hook	3 kg

These recommendations are based on your wall being without defects. It is your responsibility to secure the condition of the wall and that it can withstand the load that will be applied.

The recommendations require you to use our assembly instructions.

The recommendations also require you to use the screws and plugs recommended for your wall type, see the recommendations in our assembly instructions.

TOP TRACK AND HANG STANDARD

Everything hangs on the Top track.



Screw the Top track into the wall.



Hang the hang standards on the Top track.



Hook brackets in place.



Click in your storage functions.



HANG STANDARD

Hang the standards on the Top track and position from 45cm to 90cm apart. These hold shelves, drawers, and other storage features. Can be cut to size.

LENGTH	CODE	COLOUR
508mm	426810	white
Depth 25mm	426880	platinum
924mm	426018	white
Depth 25mm	426048	platinum
1212mm	426310	white
Depth 25mm	426380	platinum
1532mm	426618	white
Depth 25mm	426648	platinum
2012mm	426410	white
Depth 25mm	426480	platinum
2140mm	426718	white
Depth 25mm	426748	platinum
2300mm	426510	white
Depth 25mm	426580	platinum



TOP TRACK

This is the only part that attaches to the wall. Can be cut to size.

LENGTH	CODE	COLOUR
1050 mm	421110	white
7 Screw Holes	421180	platinum
1350 mm	421310	white
9 Screw Holes	421380	platinum
1950 mm	421910	white
13 Screw Holes	421980	platinum



TOP TRACK COVER

Mount on top track to hides screws and create a tidy finish.

LENGTH	CODE	COLOUR
425 mm	422418	white
pkg/2	422488	platinum
581 mm	422518	white
pkg/2	422588	platinum
876 mm	422618	white
pkg/2	422688	platinum



WALL CLIPS

Clips to secure the Hang standards to the wall in a fixed position



LENGTH	CODE	COLOUR
155 x 200mm	470718	white
With Clip 2 Pack	470768	platinum

SCREWS AND ANCHORS

LENGTH	CODE	COLOUR	
Drywall	Expander 9-26cm, 5 Pack	471890	Zinc - Plated
Concrete, Brick and Timber	Screw & Plug, 10 Pack	470696	Zinc - Plated



HANG STANDARD COVER

Mount on the hang standard and wallband to hide slots.



LENGTH	CODE	COLOUR
4224mm	427410	white
roll	427480	platinum

FREESTANDING

Freestanding is one of the mounting options within the Click-in system. A floor based solution where you click in your storage functions. Choose between double or single-sided.

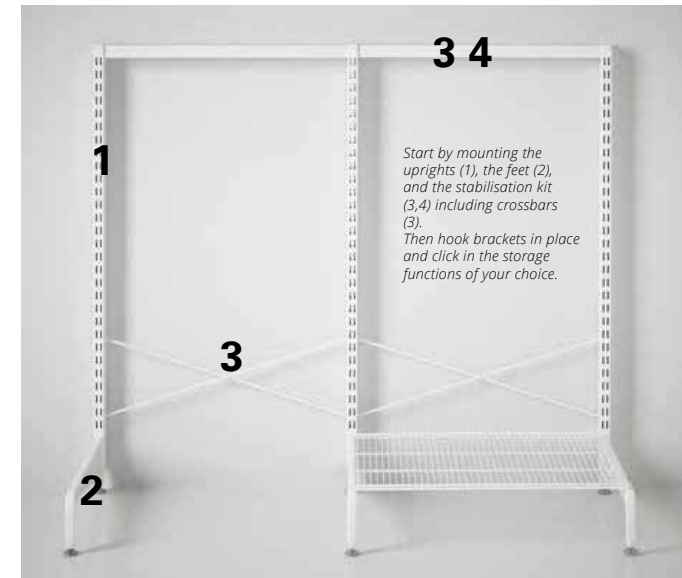

Start by mounting the uprights (1), the feet (2), and the stabilisation kit (3,4) including crossbars (3). Then hook brackets in place and click in the storage functions of your choice.

This option is ideal when you can't - or don't want to - mount your system directly on the wall e.g. when the wall can't carry the weight, there is a window or when you want to leave the wall as it is. It's also perfect as a room divider, since the upright standards are double-sided. Complement with the features you need for storage to fit e.g. clothing, garage or laundry room.

UPRIGHT

Standard to be used for freestanding click-in system, does not require a wall. Completed with feet and stabilization kit for freestanding storage.

HEIGHT X WIDTH	CODE	COLOUR
1036 x 25mm	401010	white
Depth 50mm	401080	platinum
1580 x 25mm	401510	white
Depth 50mm	401580	platinum
2124 x 25mm	402110	white
Depth 50mm	402180	platinum



5



If you want a Wire shelf at the bottom, use the enclosed clip (5).

STABILIZATION KIT

Kit to create stability in the freestanding system. Mounted between two freestanding uprights and also the feet for freestanding upright.

WIDTH X HEIGHT	CODE	COLOUR
449 x 30mm	608210	white
Depth 46mm	608280	platinum
605 x 30mm	603910	white
Depth 46mm	603980	platinum
902 x 30mm	606110	white
Depth 46mm	606180	platinum



FOOT FOR FREESTANDING UPRIGHT

Adjustable height to maintain stability despite uneven surface. Clips included to attach a Wire shelf directly to the feet.

WIDTH X HEIGHT	CODE	COLOUR
470 x 135mm	603710	white
Depth 34mm	603780	platinum
560 x 135mm	603810	white
Depth 34mm	603880	platinum



WALLBANDS, BRACKETS & ACCESSORIES

Brackets are essential building blocks in the Click-in system, to be used for attaching storage functions to the hang standards e.g. shelves and drawers.

CLICK-IN BRACKETS

Use with Wire and Decor Shelves and gliding components

LENGTH	CODE	COLOUR
320 mm	410310	white
For 300mm Shelf	410380	platinum
434 mm	414210	white
For 405mm Shelf	414280	platinum
500 mm	410510	white
For 494mm Shelf	410580	platinum



FLAT SHELF BRACKET

Recommendation: Choose a bracket for a solid or melamine shelf that is 0-30 mm shorter than the shelf depth.

LENGTH	CODE	COLOUR
120 mm	411210	white
	411280	platinum
170 mm	411710	white
	411780	platinum
220 mm	412210	white
	412280	platinum
270 mm	412710	white
	412780	platinum
320 mm	413210	white
	413280	platinum
370 mm	413710	white
	413780	platinum
470 mm	414710	white
	414780	platinum
570 mm	415710	white
	415780	platinum



BRACKET W SLOT FOR ROD HOLDER

370 mm	413715	white
	413785	platinum



SLANTING BRACKET

270 mm	412810	white
---------------	--------	-------



BRACKET CLOSET ROD HOLDER

320 mm	413010	white
	413080	platinum



CLOSET ROD HOLDER AND BRACKET COVER

Improved flexibility and maximized usage of space.

SIDE	CODE	COLOUR
Left	480710	white
	480780	platinum
Right	480610	white
	480680	platinum



BRACKET COVER

Bracket cover clicks into place on the bracket. Bracket cover give a complete appearance and hides the exposed sides of your bracket.

SIZE	CODE	COLOUR
Left	601218	white
	Depth 320mm	601288
Right	601318	white
	Depth 320mm	601388
Centre	609010	white
	Depth 321mm	609080
Left	601618	white
	Depth 420mm	601688
Right	601718	white
	Depth 420mm	601788
Center	608010	white
	Depth 421mm	608080
Left	602918	white
	Depth 500mm	602988
Right	603018	white
	Depth 500mm	603088



BRACKET HOOK

Mounted on the edge of a bracket. Smart feature for storing scarves, necklaces, keys and more.

SIZE	CODE	COLOUR
4 Hooks	473316	white
	316x47mm	473386
8 Hooks	473516	white
	316x47mm	473586
5 Hooks	473416	white
	417x47mm	473486
10 Hooks	473616	white
	417x47mm	473686

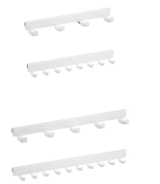

WALLBAND

A less flexible option than Top Track/Hang Standard combo. Mount with screws in the wall. Frame is 25 x 16mm. Can be cut to size.

LENGTH	CODE	COLOUR
316 mm	400310	white
	400380	platinum
636 mm	400610	white
	400680	platinum
956 mm	400910	white
	400980	platinum
1276 mm	401210	white
	401280	platinum
1596 mm	401610	white
	401680	platinum
1916 mm	401910	white
	401980	platinum
2236 mm	402210	white
	402280	platinum
2396 mm	402410	white
	402480	platinum



SHELVES

Shelves are important for efficient storage. In the Click-in system you can choose between several materials, designs, and dimensions. Use suitable click-in brackets for tool free mounting into the system. Add accessories to improve organization.

WIRE SHELVES

Use in any of our systems. Wire shelves make it easy to see the contents when stored higher up and do not collect as much dust as solid shelves.

WIDTH	CODE	COLOUR	
450 mm	452618	white	
	Depth 305mm	452648	platinum
	Depth 305mm	450210	white
607 mm	450280	platinum	
	902 mm	450410	white
		Depth 305mm	450480
1212 mm	451210	white	
	Depth 305mm	451280	platinum
450 mm	452718	white	
	Depth 405mm	452748	platinum
607 mm	450310	white	
	Depth 405mm	450380	platinum
902 mm	450510	white	
	Depth 405mm	450580	platinum
1212 mm	451610	white	
	Depth 405mm	451680	platinum
450 mm	452818	white	
	Depth 494mm	452848	platinum
607 mm	451818	white	
	Depth 494mm	451848	platinum
902 mm	451910	white	
	Depth 494mm	451980	platinum
1212 mm	452018	white	
	Depth 494mm	452048	platinum

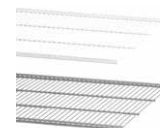
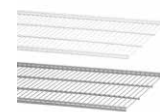

WIRE SHELF BASKETS

Use in any of our systems. Wire shelves make it easy to see the contents when stored higher up and do not collect as much dust as solid shelves.

WIDTH	CODE	COLOUR	
450 mm	457418	white	
	Depth 337mm	457448	platinum
	Depth 337mm	457018	white
607 mm	457068	platinum	
	902 mm	457110	white
		Depth 337mm	457180
450 mm	457518	white	
	Depth 438mm	457548	platinum
607 mm	457218	white	
	Depth 438mm	457248	platinum
902 mm	457318	white	
	Depth 438mm	457348	platinum



SHELF BASKET DIVIDER

Clicks into place anywhere in the wire shelf basket.

WIDTH	CODE	COLOUR
334 mm	473018	transp.
	2 Pack	
427 mm	601508	transp.
	2 Pack	



MELAMINE SHELVES

Melamine-faced particle board with edging all round. Thickness - 19cm. Installed above bracket for depth. Secure with Shelf pin or Bracket screw.

DEPTH	CODE	COLOUR
250 mm	430110	white
	Length 900mm	
300 mm	430210	white
	Length 900mm	
400 mm	430310	white
	Length 900mm	
500 mm	430410	white
	Length 900mm	
250 mm	430510	white
	Length 1200mm	
300 mm	430610	white
	Length 1200mm	
400 mm	430710	white
	Length 1200mm	
500 mm	430810	white
	Length 1200mm	
250 mm	430910	white
	Length 1800m	
300 mm	431010	white
	Length 1800m	
400 mm	431110	white
	Length 1800m	
500 mm	431210	white
	Length 1800m	



CLICK-IN MELAMINE SHELF

Shelf with smooth surface. Mounted between two Hang standard.

WIDTH	CODE	COLOUR
605 mm	656310	white
	Depth 323mm	
449 mm	654410	white
	Depth 424mm	
605 mm	656410	white
	Depth 424mm	
605 mm	656510	white
	Depth 502mm	



ANGLED METAL SHELF

Slanted metal shelf, with front edge and integrated brackets. Suitable to put shoes, books, and magazines on display.

WIDTH	CODE	COLOUR
598 mm	454510	white
	Depth 323mm	454580
Clips for Shelf		
Pack of 2	608630	clear



With our unique clothing accessories everything will have its space. We offer two designs; Décor with wooden details for a more premium and dressed look and our timeless and functional Classic, based on a heritage of great industrial design.

CLICK-IN DRAWERS

Gliding drawers create overview and easy access. We have lots of drawers in different sizes and designs for your system. Use suitable click-in brackets for tool free mounting into the system. Add accessories to improve organization.

DÉCOR SHELVES

Add timber finishes to upgrade your system.



WIDTH	CODE	COLOUR
450 mm	607615	white
Depth 437mm	607620	grey
605 mm	604215	white
Depth 437mm	604220	grey
900 mm	605215	white
Depth 437mm	605220	grey

DÉCOR ACCESSORIES

Add timber finishes to upgrade your system.

DÉCOR BRACKET HOOK RACK

63 mm	602815	white
Length 434mm	602820	grey

GLIDING PAINT RACK

600 mm	600710	white
Depth 437mm	600720	grey

GLIDING DRAWER FRAME

600 mm	600210	white
Depth 437mm	600220	grey

ACCESSORY TRAY DIVIDERS AND LID

Accessory Tray	603315	white
Width 530mm		
8 Section	603415	white
Divider		
24 Section	603515	white
Divider		
Lid	603615	white

DÉCOR MIRROR

635 mm	600015	white
Length 598mm	600020	grey

DÉCOR ACCESSORY SHELF

131 mm	607415	white
Width 605mm	607420	grey

WIRE SHELF DIVIDER

Separates the items you want to stack: sweaters, towels, linens, bags etc. Clicks into place in the wire shelf. Several dividers can be placed on shelf.



HEIGHT	CODE	COLOUR
200mm	100162	white
Depth 311mm	100298	platinum
200mm	100163	white
Depth 411mm	100248	platinum
200mm	100610	white
Depth 511mm	100680	platinum

DÉCOR FASCIA

Decorative veneer trim. Secured at the front edge of the Wire shelf.



WIDTH	CODE	COLOUR
451 mm	605915	white
Depth 34mm	605920	grey
607 mm	604915	white
Depth 34mm	604920	grey

DÉCOR FASCIA FOR GLIDING SHELF



449 mm	609115	white
Depth 25mm	609120	grey
605 mm	609215	white
Depth 25mm	609220	grey

SHELF HOOK

Hook that snaps onto the underside of a Wire shelf or Wire shelf basket for hanging handbags, belts, ties, jewelry, scarves & hats.



HEIGHT	CODE	COLOUR
81mm	472410	white
23x30 mm, pkg/2	472480	platinum

BOOK SUPPORT

Easy to create bookshelves or sideboards with your Elfa system with a combination of book supports to choose from.

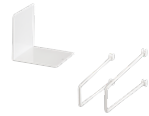

LENGTH x HEIGHT	CODE	COLOUR
130 x 130mm	464310	white
L Shaped		
200 x 75mm	465016	white
Wall Band 2 Pack	465096	platinum

BRACKET TRAY

At last, your small things get a good storage place. Mounted on the edge of a bracket.



DEPTH	CODE	COLOUR
316mm	473716	white
WIDTH 84 mm	473786	platinum
417mm	473816	white
WIDTH 84 mm	473886	platinum

WIRE SHELF BASKET DIVIDER

Clicks into place anywhere in the Wire shelf basket. Comes in a 2-pack.



HEIGHT	CODE	COLOUR
95mm	473018	transp.
334 mm, pkg/2		
95mm	601508	transp
427 mm, pkg/2		

GLIDING WIRE DRAWER

Wire drawers bundled with gliding drawer frame.



WIDTH x HEIGHT	CODE	COLOUR
448 x 85mm	234110	white
Depth 336mm		
448 x 185mm	234210	white
Depth 336mm		
605 x 85mm	236410	white
Depth 336mm		
605 x 185mm	236210	white
Depth 336mm		



449 x 85mm	264110	white
Depth 430mm	264180	platinum
449 x 185mm	264210	white
Depth 430mm	264280	platinum
449 x 285mm	264310	white
Depth 430mm	264380	platinum
605 x 85mm	266410	white
Depth 430mm	266480	platinum
605 x 185mm	266210	white
Depth 430mm	266280	platinum
605 x 285mm	266310	white
Depth 430mm	266380	platinum

DÉCOR DRAWER BOX

Provides furniture feeling and solid wood beauty. Width 60cm and Depth 40cm



HEIGHT	CODE	COLOUR
Drawer Frame	610915	white
for box	610920	grey
Box Front	611115	white
1-runner 122mm	611120	grey
Box Front	611215	white
2-runner 250mm	611220	grey

GLIDING DRAWER BUNDLE

Buy 4x gliding drawers and SAVE!
Comes complete with gliding frame and basket!



WIDTH X HEIGHT	CODE	COLOUR
605 x 185mm	166210	white
Depth 430mm		wire
605 x 185mm	166290	white
Depth 430mm		mesh

GLIDING MESH DRAWER

Mesh drawers bundled with gliding drawer frame.



WIDTH	CODE	COLOUR
448 x 85mm	234190	white
Depth 336mm		
448 x 185mm	234290	white
Depth 336mm		
605 x 85mm	236490	white
Depth 336mm		
605 x 185mm	236290	white
Depth 336mm		



449 x 85mm	264190	white
Depth 430mm	264188	platinum
449 x 185mm	264290	white
Depth 430mm	264288	platinum
449 x 285mm	264390	white
Depth 430mm	264388	platinum
605 x 85mm	266490	white
Depth 430mm	266488	platinum
605 x 185mm	266290	white
Depth 430mm	266288	platinum
605 x 285mm	266390	white
Depth 430mm	266388	platinum

DÉCOR KNOBS

Knobs to be mounted on Décor drawer fronts to create a luxury finishing. Screw for mounting included.



DIMENSIONS	CODE	COLOUR
Leather Knob	611360	brown
20x10x40mm		
Flat Knob	611420	nickel
25x25x19mm	611450	bronze
Modern Knob	611520	nickel
18x18x26mm	611550	bronze

MESH DRAWER DIVIDER

Creates separate compartments inside the mesh drawer.



WIDTH X HEIGHT	CODE	COLOUR
10 x 80 mm	223490	white
Depth 431mm	223488	platinum
10 x 180 mm	223590	white
Depth 431mm	223588	platinum

CLOSET RODS AND ORGANISERS

Create order and overview in your wardrobe. With our unique clothing accessories everything will have its space. We offer two designs.

CLOSET ROD

Ø 25 mm Hang shirts and jackets even in a shallow space.



LENGTH	CODE	COLOUR
480mm	620405	silver
635mm	620605	silver
930mm	620905	silver
1245mm	621205	silver
1850mm	621805	silver

VALET ROD



272mm Depth 305 mm	491688	chrome
387mm Depth 405 mm	602788	chrome

EXPANDING VALET ROD



Expd. 286mm Depth 63mm	605730	chrome
---------------------------	--------	--------

DOUBLE RAIL



598 x 101mm Depth 22mm	605816 605886	white platinum
---------------------------	------------------	-------------------

GLIDING TIE AND BELT RACK



395 x 143mm Depth 120mm	490980	platinum /chrome
----------------------------	--------	---------------------

ORGANISERS & ACCESSORIES



WIDTH	CODE	COLOUR
35 mm Depth 25mm	470910 470980	white platinum

END CAPS



18mm 25x18 mm, pkg/2	623905	silver
18mm 25x18 mm, pkg/2	623924	black

LABEL HOLDER - 4 Pack



22 x 8 x 49mm For drawers	475630	transp.
37 x 9 x 85mm For drawers	223030	transp.
33 x 16 x 102mm For wire shelf	100527	transp.

PANT AND SHOE STORAGE

Create an overview so it's easy to find your shoes/pants



GLIDING PANT RACK

449mm, 6 prongs	264510	white
605mm, 10 prongs	266110 266180	white platinum



GLIDING SHOE RACK

Triple, 448 x 96 mm	267310	white
Triple, 605 x 96 mm	266610 266680	white platinum



GLIDING SHOE SHELF

96 x 430mm Depth 450mm	486290 486288	white platinum
96 x 430mm Depth 605mm	486190 486188	white platinum



SINGLE SHOE SHELF

92 x 598mm Depth 194mm	482010 482080	white platinum
---------------------------	------------------	-------------------

MESH DRAWER DIVIDER

Allows small items to be organised and gives a good overview. Clicks into place in any position. Comes in a 2-pack.



WIDTH X HEIGHT	CODE	Colour
10 x 80mm Depth 431mm	223290 223288	white platinum
10 x 180mm Depth 431mm	223390 223388	white platinum

PLASTIC LINER

Positioned above the Wire shelf to provide a solid surface. Also offers options for books and binders.



WIDTH	CODE	COLOUR
450 mm Depth 291mm	614330	transparent
606 mm Depth 291mm	616330	transparent
901 mm Depth 291mm	619330	transparent
450 mm Depth 393mm	614430	transparent
606 mm Depth 393mm	616430	transparent
901 mm Depth 393mm	619430	transparent

GARAGE, LAUNDRY & CLEANING

With our functional accessories, you can create all the space you need to hang, sort and fold clothes. And organise detergents, linen, towels and pegs. Organise tools, gadgets, sports and gardening equipment

UTILITY LAUNDRY + GARAGE ACCESSORIES

Practical and efficient wallstorage for your garage, laundry storage room or garden shed.



DEPTH X HEIGHT	CODE	COLOUR
----------------	------	--------

DRYING RACK

25 x 602mm Width 640mm	493510	white
25 x 602mm Width 935mm	493610	white

MESH STORAGE BAG Ø310MM

885 mm pkg/1	477370	grey
-----------------	--------	------

UTILITY TRACK

10 x 47mm Length 419mm	473910 473980	white platinum
10 x 47mm Length 575mm	476010 476080	white platinum

FITTINGS FOR UTILITY TRACK

25 x 60mm Width 32mm	476110 476180	white platinum
-------------------------	------------------	-------------------

ACCESSORY HOOK

96 x 38mm pkg/3	477810 477870	white grey
--------------------	------------------	---------------

TOOL HOLDER

Ø 20-30mm Small, pkg/2	477610 477670	white grey
Ø 30-40mm Large, pkg/2	477710 477770	white grey

WIDE LADDER HOOK

201 x 177mm Width 173mm	476970	grey
----------------------------	--------	------

STRAIGHT HANDLED TOOL HOOK

244 x 109mm Width 70mm	476470	grey
---------------------------	--------	------

ROUND CORD HOOK

142 x 252mm Width 102mm	477270	grey
----------------------------	--------	------

VERTICAL BIKE HOOK

98 x 279mm Width 147mm	477170	grey
---------------------------	--------	------

HORIZONTAL BIKE HOOK

313 x 107mm Width 253mm	477070	grey
----------------------------	--------	------

BRACKET INSERT FOR TIRES

270 x 23mm Width 17mm	478270	grey
--------------------------	--------	------

BRACKET POST

420 x 100mm Width 17mm	478170	grey
---------------------------	--------	------

CLICK-IN WORK SURFACE

515 x 32mm Width 605mm	455570	grey
---------------------------	--------	------

ACCESSORIES FOR STORING BOARD

A storing board lets you combine small shelves, boxes and hooks for versatile storage.



BOXES - STORING BOARD & RACK

Peg Board Cup 75 mm, pkg/2	479870	grey
146 x 57mm 110 mm	478870	grey

HOOKS - STORING BOARD & RACK



Short Hook 35mm, pkg/5	479070	grey
Long Hook 65mm, pkg/4	479170	grey



Wrench Holder Pair	478470	grey
Hook Pliers 45 mm, pkg/2	479270	grey



Multi Holder 190 mm, pkg/1	478570	grey
Round Hook 92 mm, pkg/2	479770	grey



Round Hook 120 mm, pkg/2	479670	grey
Circle Hook ø 80 mm, pkg/1	479470	grey

Set of Hooks pkg/8	479970	grey
-----------------------	--------	------

SHELF / TRAY

Reversible shelf with integrated bracket. Available in several sizes. Mounted between two Hang standards.



LENGTH X HEIGHT	CODE	COLOUR
442 x 115mm Depth 48mm	454110 454180	white platinum
442 x 267mm Depth 48mm	454310 454380	white platinum
598 x 115mm Depth 48mm	453110 453180	white platinum
598 x 267mm Depth 48mm	453310 453380	white platinum

BOXES FOR SHELF/TRAY



147 x 98mm Depth 48mm	475130	frosted
98 x 98mm Depth 48mm	475230	frosted
98 x 100mm Depth 48mm	475330	frosted

STORING BOARD

Storing board to support organisation and storage of for example small items and tools. Complement with Elfa hooks, shelves, and boxes for improved organisation. Mounted between two hang standards.



STORAGE BOARD AND ACCESSORIES

WIDTH X HEIGHT CODE COLOUR

STORING BOARD

442 x 382mm	468310	white
Depth 15mm	468380	platinum
598 x 382mm	478310	white
Depth 15mm	478380	platinum
893x 382mm	478610	white
Depth 18mm	478680	platinum

BOARD WALL MOUNTS - 2 PACK

20 x 382mm	478716	white
Depth 17mm	478786	platinum

SHELF - STORING BOARD & RACK

274 x 25mm	475716	white
Depth 113mm	475786	platinum

BOXES - STORING BOARD & RACK

122 x 80mm	475430	frosted
Depth 110mm		
112 x 48mm	475530	frosted
Depth 110mm		
112 x 60mm	474830	frosted
Depth 80mm		

HOOKS - STORING BOARD & RACK

Board Short	474710	white
40mm, pkg/3	474780	platinum
Board Long	474610	white
68mm, pkg/3	474680	platinum
Board Circle	474510	white
49mm, pkg/3	474580	platinum
Board Curve	474410	white
40mm, pkg/3	474480	platinum
Basic Hook	475010	white
40mm, pkg/3	475080	platinum
Slim Hook	474910	white
31mm, pkg/6	474980	platinum
Double Hook	479510	white
D40mm, pkg/3	479580	platinum

ON DOOR STORAGE

Make use of otherwise wasted space on door. No tools required, quick installation using over door hooks. Add baskets and boards of different sizes.



UTILITY DOOR & WALL RACK SYSTEM

WIDTH X HEIGHT CODE COLOUR

OVER-DOOR HOOK

68 x 150mm	330410	white
Door 40mm	330480	platinum

STORING BOARD CENTER

459 x 16mm	333710	white
Depth 388mm	333780	platinum

STORING RACK CENTER

459 x 16mm	333810	white
Depth 67mm	333880	platinum

DOOR AND WALL STORAGE - WIRE

435 x 70mm	333210	white
Depth 79mm	333280	platinum
435 x 70mm	333110	white
Depth 104mm	333180	platinum
435 x 140mm	333010	white
Depth 134mm	333080	platinum

DOOR AND WALL STORAGE - MESH

435 x 70mm	333290	white
Depth 79mm	333288	platinum
435 x 70mm	333190	white
Depth 104mm	333188	platinum
435 x 140mm	333090	white
Depth 134mm	333088	platinum

MEDIA RACK

435 x 70mm	334310	white
Depth 167mm	334380	platinum

MEDIA RACK DIVIDER

159 x 67mm	334430	transl.
Pack of 2		

STARTER PACKS

For our most popular click-in top hang combinations, we have created ready solutions with complete picking lists. Just choose the solution that matches your needs and space.

* Props, top track cover, and bracket cover not included.



STARTER PACK - 1950x2012mm CODE:411220

COMPONENT	CODE	COLOUR	QTY
Shelf 607 x 405mm	450310	white	x1
Shelf 1212 x 405mm	451610	white	x1
2 Slot Bracket 420mm	414210	white	x4
Top Track 1950mm	421910	white	x1
Hang Standard 2011mm	426410	white	x4
Closet Rod 1850mm	621805	silver	x1
End Caps Set of 2	623924	Black	x1
Rod Holders 77mm	470910	white	x4



STARTER PACK - 1950x2012mm CODE 412720

COMPONENT	CODE	COLOUR	QTY
Shelf 607 x 405mm	450380	platinum	x1
Shelf 1212 x 405mm	451680	platinum	x1
2 Slot Bracket 420mm	414280	platinum	x4
Top Track 1950mm	421980	platinum	x1
Hang Standard 2011mm	426480	platinum	x4
Closet Rod 1850mm	621805	silver	x1
End Caps Set of 2	623924	Black	x1
Rod Holders 77mm	470980	platinum	x4

STARTER PACK - 1350x1212m
CODE: 590112

COMPONENT	CODE	COLOUR	QTY
Shelf 1212 x 405mm	451610	white	x1
2 Slot Bracket 420mm	414210	white	x2
Top Track 1350mm	421310	white	x1
Hang Standard 1212mm	426310	white	x2
Closet Rod 1245mm	621205	silver	x1
End Caps Set of 2	623924	Black	x1
Rod Holders 77mm	470910	white	x2



STARTER PACK - 590348
1350x2012mm

COMPONENT	CODE	COLOUR	QTY
Shelf 1212 x 306mm	451210	white	x1
3 Slot Bracket 320mm	410310	white	x3
Top Track 1350mm	421310	white	x1
Hang Standard 2012mm	426410	white	x3
Closet Rod 1245mm	621205	silver	x1
End Caps Set of 2	623924	Black	x1
Rod Holders 77mm	470910	white	x3



STARTER PACK - 411720
1350x2012mm

COMPONENT	CODE	COLOUR	QTY
Shelf 607 x 305mm	450210	white	x1
Shelf 1212 x 305mm	451210	white	x1
3 Slot Bracket 320mm	410310	white	x5
Top Track 1350mm	421310	white	x1
Hang Standard 2011mm	426410	white	x3
Closet Rod 635mm	621205	silver	x1
Closet Rod 1245mm	620605	silver	x1
End Caps Set of 2	623924	Black	x2
Rod Holders 77mm	470910	white	x4

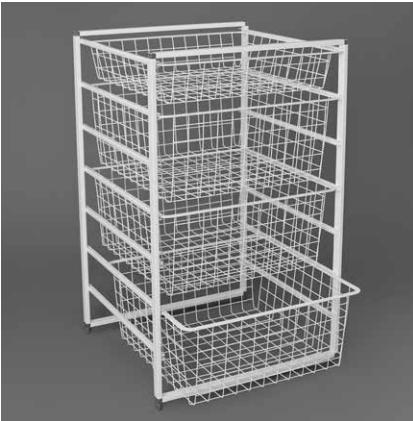

BASIC DRAWER SET
CODE: 100019 - Wire 74 - 45

Side Frame 7-Runners x1 280713 (740x435mm)	Crossbars Set x1 204014 (450mm)
Wire Drawer x3 144210 (427x185mm)	Wire Drawer x1 144110 (427x85mm)



BASIC DRAWER SET
CODE: 744590 - Mesh 74 - 45

Side Frame 7-Runners x1 200713 (740x435mm)	Crossbars Set x1 204014 (450mm)
Mesh Drawer x3 145290 (427x185mm)	Mesh Drawer x1 145190 (427x85mm)



UTILITY DOOR & WALL RACK KIT
CODE: 334610

Large Basket x1 333010 (435mm)	Medium Basket x1 333110 (435mm)	Storing Rack x1 333810 (459mm)
Small Basket x1 333210 (435mm)	Basic Hook 3pk x1 475010 (40mm)	

DRAWER SYSTEM

A floor based system built on frames, crossbars, and drawers. Can be placed in e.g. closets and laundry rooms - freestanding, and on wheels. Combine with drawer units and add accessories to build a storage system fitting your needs and space e.g. under a staircase.

Drawers can be used in existing wardrobes or cupboards, when slid into runners, mounted onto the wardrobe side walls.



1. CASTERS
2. MESH DRAWER
3. TOP SHELF
4. WIRE DRAWER
5. FRAME SIDE CLIPS
6. FRAME FEET
7. FRAME SIDES
8. EXTENSION KIT
9. CLOSET ROD
10. CLOSET ROD HOLDER FRAME-WALL



11. TIE AND BELT RACK
12. CROSSBARS
13. HOOK RACK
14. SIDE BASKET
15. SHOE RACK

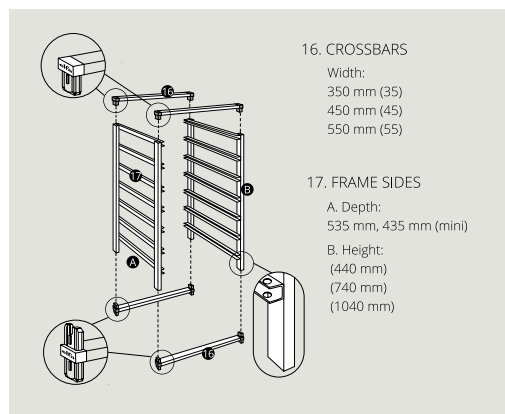

16. CROSSBARS
Width:
350 mm (35)
450 mm (45)
550 mm (55)
17. FRAME SIDES
A. Depth:
535 mm, 435 mm (mini)
B. Height:
(440 mm)
(740 mm)
(1040 mm)

GET SET IN 3 SIMPLE STEPS

FRAMES
Frame sides to build freestanding Drawer system. Complement with Crossbars and Drawers for complete storage solution. Supplement with Top shelf to create solid work surface and Extension kit to stack multiple units.

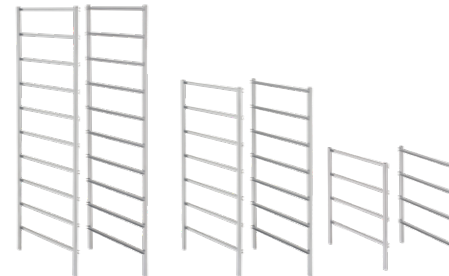

The colour guide indicates which crossbars, frame sides and drawers fit together.

	Frame Sides Mini (Depth:435mm)	Frame Sides (Depth:535mm)
Pair 440 mm	280413 white	200413 white
Depth 435mm	280483 platinum	200483 platinum
740 mm	280713 white	200713 white
Depth 435mm	280783 platinum	200783 platinum
1040 mm	281013 white	201013 white
Depth 435mm	281083 platinum	201083 platinum

MESH DRAWER
Installed between two frame sides. Combine with crossbars of suitable width.

	WIDTH x HEIGHT	CODE	COLOUR
●	327 x 85mm	135190	white
	Depth 527mm	135188	platinum
	327 x 185mm	135290	white
	Depth 527mm	135288	platinum
●	327 x 285mm	135390	white
	Depth 527mm	135388	platinum
	427 x 85mm	145190	white
	Depth 527mm	145188	platinum
●	427 x 185mm	145290	white
	Depth 527mm	145288	platinum
	427 x 285mm	145390	white
	Depth 527mm	145388	platinum
●	527 x 85mm	155190	white
	Depth 527mm	155188	platinum
	527 x 185mm	155290	white
	Depth 527mm	155288	platinum
●	527 x 285mm	155390	white
	Depth 527mm	155388	platinum

1.) Choose crossbars according to your desired width of drawers.

2.) Choose frames according to your desired height and depth of your drawer unit. The amount of frame side runners decides how many drawers you can fit and the height of the drawers.

3.) Choose between wire and mesh drawers and accessories according to your needs.

WIRE DRAWER
Installed between two frame sides. Combine with crossbars of suitable width.

	WIDTH x HEIGHT	CODE	COLOUR
●	327 x 85mm	135110	white
	Depth 527mm	135180	platinum
	327 x 185mm	135210	white
	Depth 527mm	135280	platinum
●	327 x 285mm	135310	white
	Depth 527mm	135380	platinum
	427 x 85mm	145110	white
	Depth 527mm	145180	platinum
●	427 x 185mm	145210	white
	Depth 527mm	145280	platinum
	427 x 285mm	145310	white
	Depth 527mm	145380	platinum
●	527 x 85mm	155110	white
	Depth 527mm	155180	platinum
	527 x 185mm	155210	white
	Depth 527mm	155280	platinum
●	527 x 285mm	155310	white
	Depth 527mm	155380	platinum
	●	327 x 85mm	134110
Depth 427mm		134180	platinum
●		327 x 185mm	134210
	Depth 427mm	134280	platinum
	●	327 x 285mm	134310
Depth 427mm		134380	platinum
●		427 x 85mm	144110
	Depth 427mm	144180	platinum
	●	427 x 185mm	144210
Depth 427mm		144280	platinum
●		427 x 285mm	144310
	Depth 427mm	144380	platinum
	●	527 x 85mm	145110
Depth 427mm		145180	platinum
●		527 x 185mm	145210
	Depth 427mm	145280	platinum
	●	527 x 285mm	145310
Depth 427mm		145380	platinum

CROSS BARS

The crossbar determines the width of the drawer unit. Extension kits allow draw units to be stacked. Comes in a 2-pack.



HEIGHT X DEPTH	CODE	COLOUR
44 x 20mm Width 350mm	203014	white
	203084	platinum
44 x 20mm Width 450mm	204014	white
	204084	platinum
44 x 20mm Width 550mm	205014	white
	205084	platinum

EXTENSIONS KITS



44 x 20mm Width 350mm	213014	white
	213084	platinum
44 x 20mm Width 450mm	214014	white
	214084	platinum
44 x 20mm Width 550mm	215014	white
	215084	platinum

ACCESSORIES FOR DRAWER FRAMES

HEIGHT X DEPTH	CODE	COLOUR
----------------	------	--------

32-HOOK TIE AND BELT RACK



68 x 52mm Width 515mm	325510	white
	325580	platinum

ACCESSORY/SIDE BASKET



136 x 150mm Width 515mm	325710	white
	325780	platinum
136 x 150mm Width 415mm	325910	white
	325980	platinum

5-HOOK RACK



106 x 48mm Width 525mm	326110	white
	326180	platinum
106 x 48mm Width 425mm	326210	white
	326280	platinum

SHOE RACK



128 x 104mm Width 515mm	325610	white
-----------------------------------	--------	-------

ADJUSTABLE FEET



50-63mm Pack of 4	493720	black
-----------------------------	--------	-------

CLIP ON CASTERS



89x 65mm Pack of 4	222020	black
------------------------------	--------	-------

FRAME FEET



20x 20mm Pack of 4	222730	clear
------------------------------	--------	-------

IN/OUT STOPS - 4 Pack



For Wire Drawers	225930	clear
For Mesh Drawers	227930	

BACK STOP PINS



Fits 5 Drawers Pack of 10	226990	steel
-------------------------------------	--------	-------

TOP SHELF

Shelf that is placed on top of Drawer system unit to create a solid storage area on top. Use double-sided tape to secure.



HEIGHT X DEPTH	CODE	COLOUR
----------------	------	--------

TOP SHELF

16 x 535mm
Width 350mm

224113 white

16 x 535mm
Width 450mm

224213 white

16 x 535mm
Width 550mm

224313 white



16 x 435mm
Width 350mm

225613 white

16 x 435mm
Width 450mm

225713 white

16 x 435mm
Width 550mm

225813 white

ROD HOLDER

With the help of our closet rod holders for tower/wall you can easily connect your floor based solution to the wall.



HEIGHT X DEPTH	CODE	COLOUR
----------------	------	--------

ROD HOLDER, FRAME/FRAME - 2 Pack

116 x 37mm

222310 white

Width 39mm

222340 platinum

ROD HOLDER, WALL/WALL - 2 Pack

44 x 32mm

624510 white

Width 25mm

624540 platinum

ROD HOLDER, FRAME/WALL - 2 Pack

116 x 37mm

222610 white

Width 39mm

222640 platinum

CENTRAL ROD HOLDER

44mm

624210 white

Width 39mm

624240 platinum

RUNNERS

Runner to integrate Elfa drawers in existing cabinets.

RUNNERS PAIR

Suitable for spaces with pre-drilled holes with defined center-to-center measurement



WIDTH X HEIGHT	CODE	COLOUR
----------------	------	--------

26 x 31mm

220510 white

Length 550mm

Suitable for spaces with pre-drilled holes with 468 mm center-to-center measurement. Pair.



29 x 41mm

220810 white

Length 490mm

Suitable for spaces with pre-drilled holes with 448 mm center-to-center measurement. Pair.

CREATE YOUR OWN DREAMY (AND FUNCTIONAL) CLOSET

Achieving your dream closet is easier than ever. The Décor range has a wide selection of stylish fixtures, fittings and accessories which allows for both a stylish and functional closet. There are also some valuable tips to have in mind when planning, to maximise the use of space, create overview and an airy closet solution.

HANG AS MUCH AS POSSIBLE

Hang as much as possible, preferably at two heights. The benefits are extra space, easy access and clothes that are free of creases. Hang all the way in the corners, to use the space efficiently.



KEEP THE FLOOR FREE

This will create an airy feel to the room and make the room easier to clean.



HANG OR FOLD YOUR PANTS

Jeans can be stored folded, or rolled up, while more formal trousers are best hung on extendable pant racks. This separates them for easy selection, keep them wrinkle free and takes up less space than hangers.



CREATE EASY ACCESS

Robes, jeans and clothes that you use frequently can be hung on hooks inside or on the sides of your storage solution.



STORE BY CATEGORY

A good way to store your clothes is by dividing the solution into sections for job, leisure and party. Another way is sorting by colour. To keep a clean look, use identical hangers in the entire closet.



SPACING MATTERS

Recommended spacing between each shelf is 35 cm, when you store folded clothes. This way you won't get an overloaded closet.

REGULAR RINSE

Tip for keeping your wardrobe current and up-to-date; store away clothes you rarely use and see if you miss them after six months.

ASSEMBLY & INSTALLATION GUIDE

PLEASE READ ALL OF THE INSTRUCTIONS BEFORE BEGINNING ASSEMBLY.

Tools needed: pencil, scissors, level, power drill, drill bits, #2 Phillips head bit for power drill, #2 Phillips head screwdriver, hammer, tape measure, ladder or step stool.

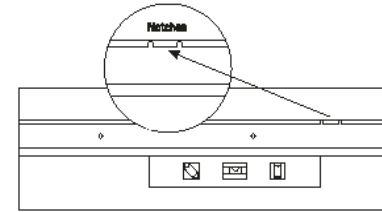

Top tracks have a top and a bottom. The TOP is designated by a label and has two notches to allow hang standards to be inserted properly.

ASSEMBLY HARDWARE FOR TOP TRACK



#2 Bit

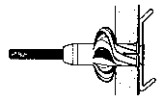

Expander for single plasterboard (G5)

Used for 1/2"/13 mm or 5/8"/17 mm thick drywall. Use 3/8"/10 mm drill bit to drill hole. Insert dark blue anchor, remove and discard the gray spacer. Use #2 Phillips head bit to tighten the screw.

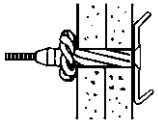

Expander for double plasterboard (G6)

Used for 1"/18-30 mm thick plaster or drywall. Use 3/8"/10 mm masonry drill bit to drill hole. Insert red anchor, remove and discard the gray spacer. Use #2 Phillips head bit to tighten the screw.

Screw and plug | Other Installation Hardware for Special Wall Construction

Wood

Used for mounting into drywall over wood studs or directly into wood. Use 1/8"/3 mm drill bit to drill a pilot hole the length of the bit. Discard anchor. Use #2 Phillips head bit to tighten the screw.

Concrete walls

Used for mounting into masonry walls, concrete, brick, etc. Use 5/16"/8 mm masonry drill bit to drill hole. Insert light blue anchor. Use #2 Phillips head bit to tighten the screw.



Position the top track

Place top track at desired height, mark one hole in the middle, and take the top track down. It is usually placed at ceiling or door height, but may be placed at any height.

Begin drilling the marked hole with a 1/8"/3mm drill bit. If you hit wood, continue drilling the entire length of the bit. If you hit the hollow part of the wall, enlarge the hole with a 3/8"/10mm drill bit for the hollow wall anchors.

Put the top track up with one screw and tighten it enough to hold the top track against the wall.

To keep the top track level while you mark all of the holes, place a level on the top of the top track and adjust it as required.

Drill all marked holes and put up the top track

Take the top track off of the wall. Drill holes with a 1/8"/3 mm drill bit, assuming you are going into wood. If you hit wood, continue drilling the entire length of the bit. Put the top track up and insert and tighten all the screws.

If you hit the hollow part of the wall, mark those holes with an X, reminding yourself you need to go back and drill a 3/8"/10 mm hole for the hollow wall anchors.

EASY HANG VENTILATED SHELVING COMPONENTS

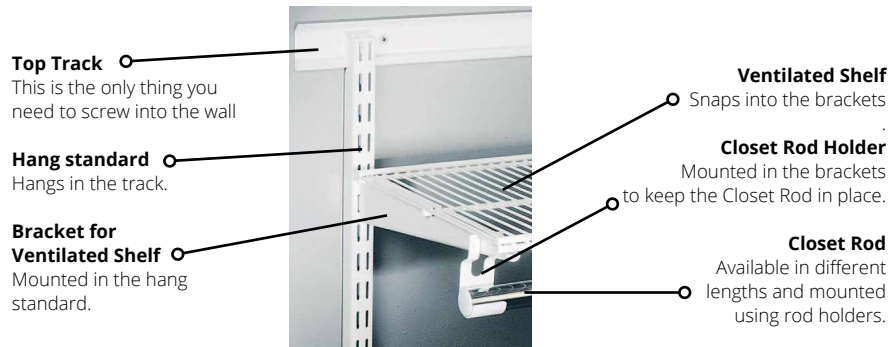

EASY HANG INSTALLATION - VENTILATED SHELVING

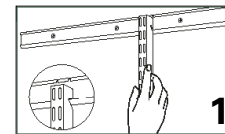

Insert the hang standards in the top track notches.

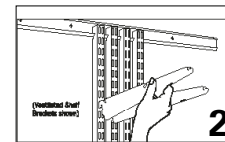

Hanging Standards should be placed at a maximum of 36"/900 mm apart in closets, 24"/600 mm apart for storage of heavy items

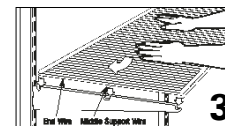

Place Shelf wires over notches in the Ventilated Shelf Bracket. The end of the Shelf should extend 1/2"/10 mm past the side of the Bracket. Lock the Shelf into place by pressing the middle part down and toward the wall. To unlock the Shelf, lift the back out of the slot and pull away from the wall. Snap the Closet Rods into their Holders

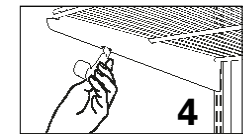

Insert the closet rod holder into the slot in the bottom of the bracket click in.

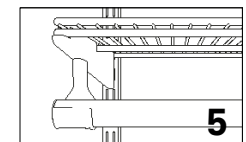

Snap in the closet rod Tap the end caps into both ends of the closet rod. Snap the closet rod into the closet rod holder.

NEW GREY
DÉCOR





NEW WHITE
DÉCOR

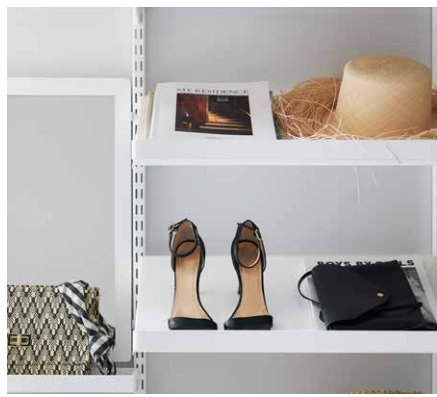



LAUNDRY

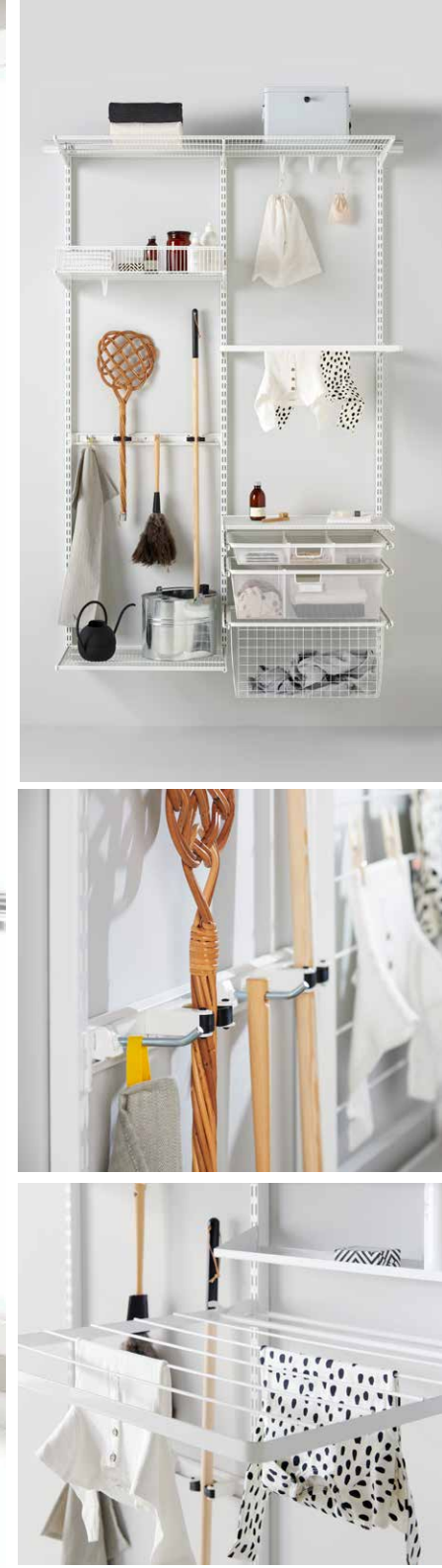



GARAGE

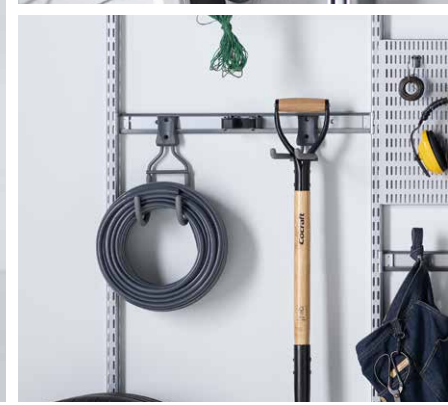

CREATING SPACE IN EVERYDAY LIFE

Our guess is that clothes, shoes and things fill your home – they are everywhere and not always where you want them to be. With ingenious storage solutions things will find their place and you will find your things. We can inspire you to recover cubic metres you may have lost to temporary solutions.

Storage that creates space will bring back and improve your living space, allowing you to put it to better use for hobbies, activities or precious time with loved ones.

www.elfa.com



www.formfunctionnt.com.au

sales@formfunctionnt.com.au

08 89 410588